

HTH

10.10

The HTH 10.10 telescopic handler is ideal for moving large, bulky loads in complete safety. Able to lift up to 10 tonnes, it is compatible with a wide range of accessories, making it extremely versatile. Equipped with an RFID system which provides automatic recognition of the various attachments used, this telescopic handler is able to meet a wide range of applications in heavy industry. Its four-wheel drive system, three manoeuvring modes and high ground clearance makes it highly manoeuvrable on all terrain types.



MAIN SECTORS



HEAVY
INDUSTRY



HEAVY
LOGISTICS



MINING &
QUARRING



SPECIAL
PROJECTS

HTH 10.10

Machine model	Maximum lifting capacity	10,000 kg
	Load center	600 mm
	Maximum lifting height	9,50 m
	Maximum reach	5.00 m
Engine	Type	Deutz TCD 3,6 L4 - Stage V Deutz TCD 3,6 L4 - Stage IV Deutz TCD 3,6 L4 EDG - Stage IIIA
	Rated power	100 kW (136 hp) @ 2,200 rpm
	Maximum torque	500 Nm @ 1,600 rpm
	Displacement	3.6 l
	Cylinders	4 in line
	Engine configuration	Turbocharged direct injection diesel
	Cooling system	Water - intercooler
Cab	FOPS-ROPS tested hermetic cab with protectors	•
	Front, rear and upper wiper	•
	Headlights for road circulation, flashing beacon	•
	Rear view mirrors	•
	Heating - Air conditioning	•
Controls	Multi-function electro proportional joystick	•
	Heavy Duty with epicyclic reduction	•
	One steering cylinders each axle	•
	Levelling correction front axle	+ 8° on the right and + 8° on the left
Axles and brakes	3 types of steering	- with front steering - with round steer - with crab steering
	Tilting rear axle	•
	Hydraulic servo-assisted multidisc brake in oil bath on both axles, with double circuit	•
	Negative parking brake	•
	Tyre size	445/65 - R22,5 ** two each axle, driving and steering
Performance	Max. travel speed	40 km/h
	Drawbar pull	84 kN
	Gradeability	66%
	Turning radius (at wheels)	4,100 mm
Weights	Total unladen	13,100 kg
	Front axle unladen (boom retracted and lowered)	4,600 kg
	Rear axle unladen (boom retracted and lowered)	8,500 kg
Transmission	Hydrostatics	Rexroth / Danfoss
	Variable displacement hydrostatic pump with electronic control	•
	Variable displacement hydrostatic motor	One
	Gearbox	Gearbox with 2 speeds forward / reverse
Hydraulic circuit	Load sensing piston pump	•
	Circuit at 350 bar	•
	Proportional hydraulic electrovalve	Danfoss
	Suction and return line filters	•
	High pressure flexible hoses	•
Tanks capacities	Diesel fuel tank	195 l
	AdBlue*	10 l
	Hydraulic fluid	190 l
	Engine oil	9 l
	Cooliant	20 l
Safety	Electronic safety system which controls the load with definition of the lifted load, radius and comparison with the diagrams stored	•
	Block of aggravating movements of the load	•
	Safety valves on cylinders	•

HTH 10.10

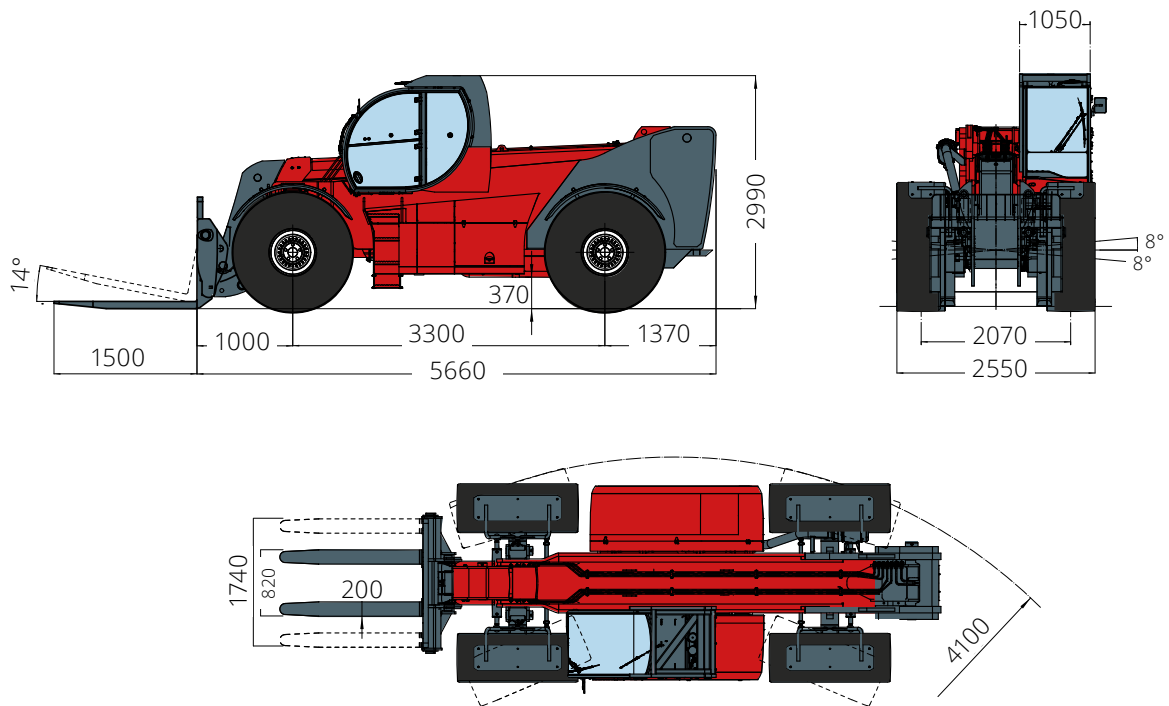

Load chart
with forks

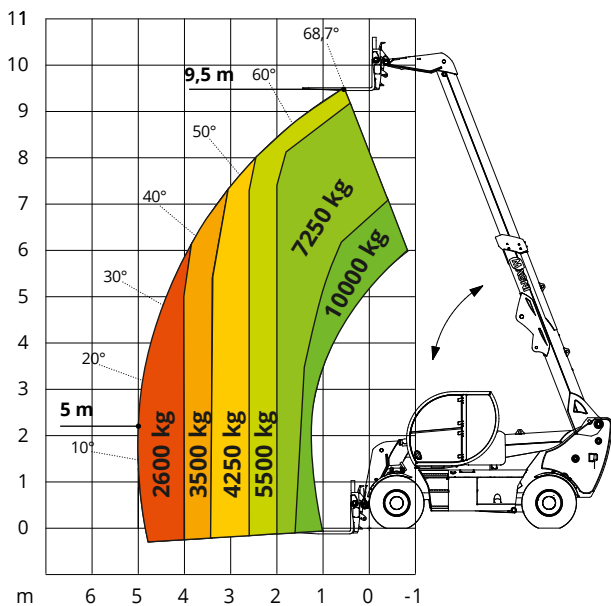

Load chart with tyres clamp
model TC 3,8-49

